

PW3017-115

K-Ka-Band Dual-Port (RHCP+LHCP) Horn Antenna, 15 dB

Features

- ✓ Broadband
- ✓ Shared aperture with separate RHCP and LHCP ports
- ✓ Excellent port to port isolation
- ✓ Extremely durable

Benefits

- ✓ Commercial off-the-shelf (COTS)
- ✓ Customization available

Product Overview

The PW3017-115 is a compact, high-accuracy horn antenna designed for versatile performance. It features two 2.92mm connectors, one for RHCP polarization and the other for LHCP. With broadband operation across both ports from 17 to 30 GHz, this antenna is ideal for use on either side of a SATCOM link: space or ground.

This antenna is a perfect choice for a variety of RF laboratory applications, including antenna ranges, emerging wireless technology link setups and more.

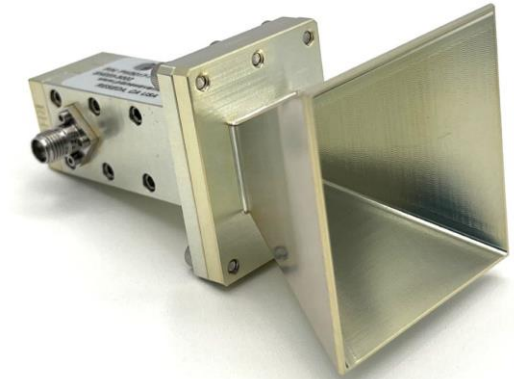

Related Products

Part Number	Description
PW3017-100	K-Ka-Band Dual-Port (RHCP+LHCP) Waveguide Probe
PW3017-120	K-Ka-Band Dual-Port (RHCP+LHCP) Horn Antenna, 20 dB
PW4018-100	Dual-Ridged Horn Antenna, 18-40 GHz
PW4010-101	Quad-Ridged Horn Antenna, 10-40 GHz

Information furnished by PlaneWave, Inc. is believed to be accurate and reliable. However, no responsibility is assumed by PlaneWave for its use, nor for any infringements of patents or other rights of third parties that may result from its use.

Electrical Specifications

Parameter / Condition	Min	Typ	Max	Unit
Operating Frequency	17		30	GHz
Polarization	RHCP/LHCP			
VSWR			2:1	
Gain	15		18	dBic
Power Handling (CW)			10	W
Operating Temperature	-40		85	°C

Mechanical Specifications

Parameter / Condition	Value	Unit	Limits
Connector	2.92 mm Female		
Mass	100	g	Max

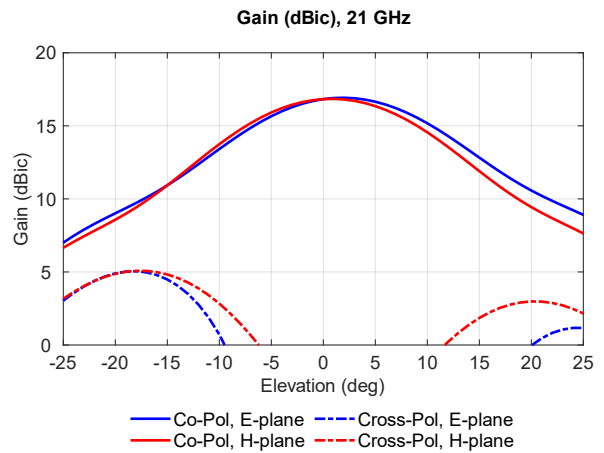
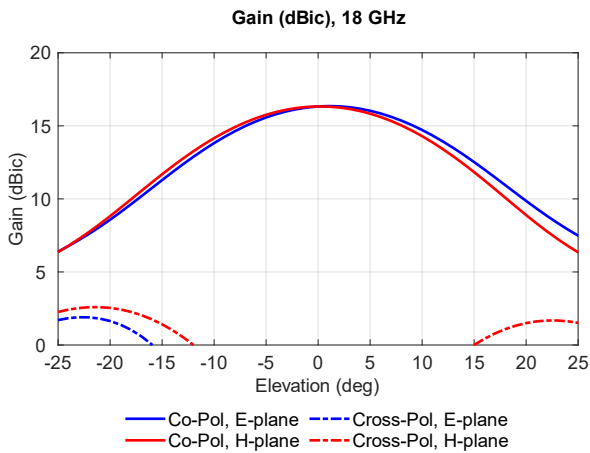

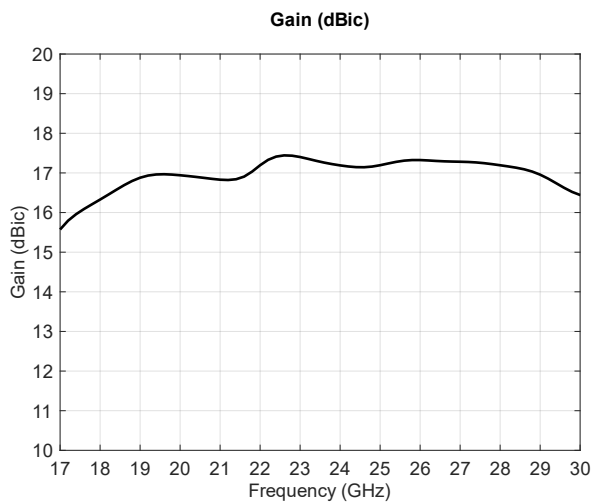
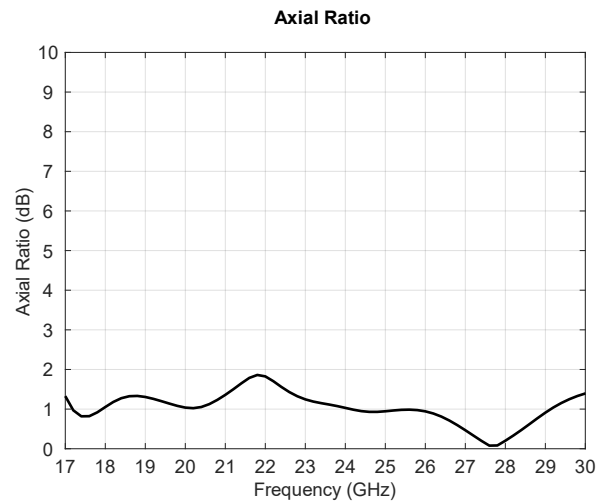
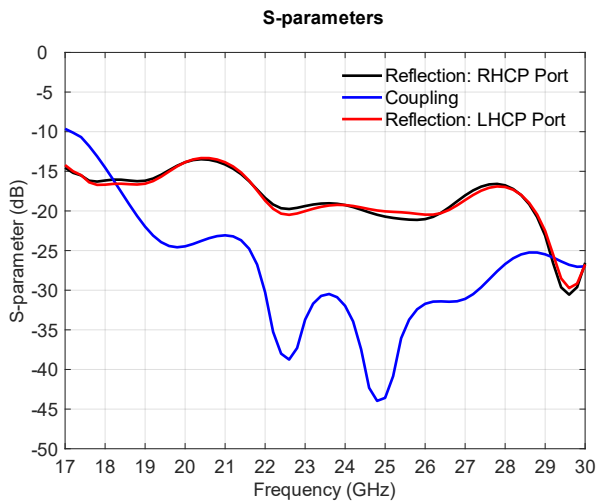
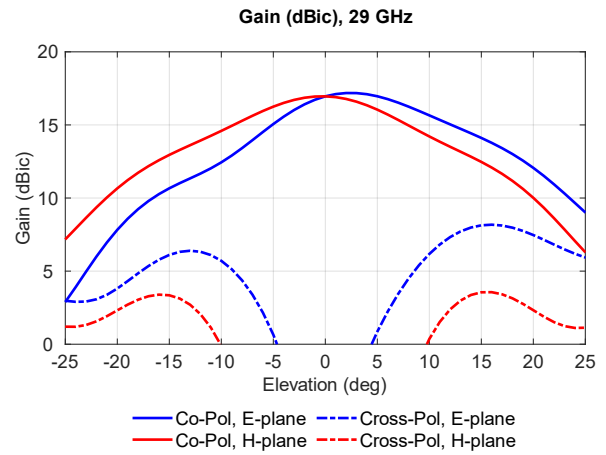
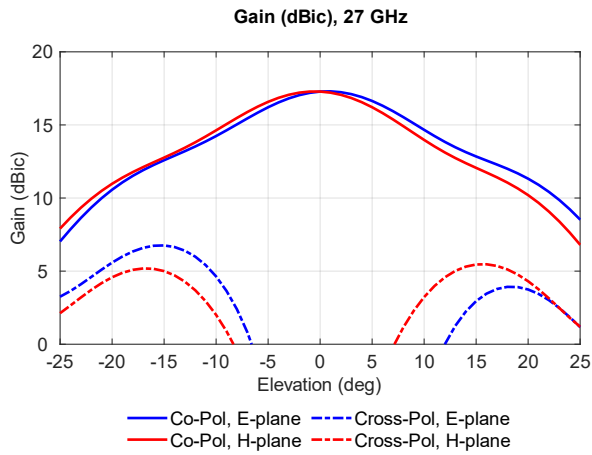

Mechanical Outline

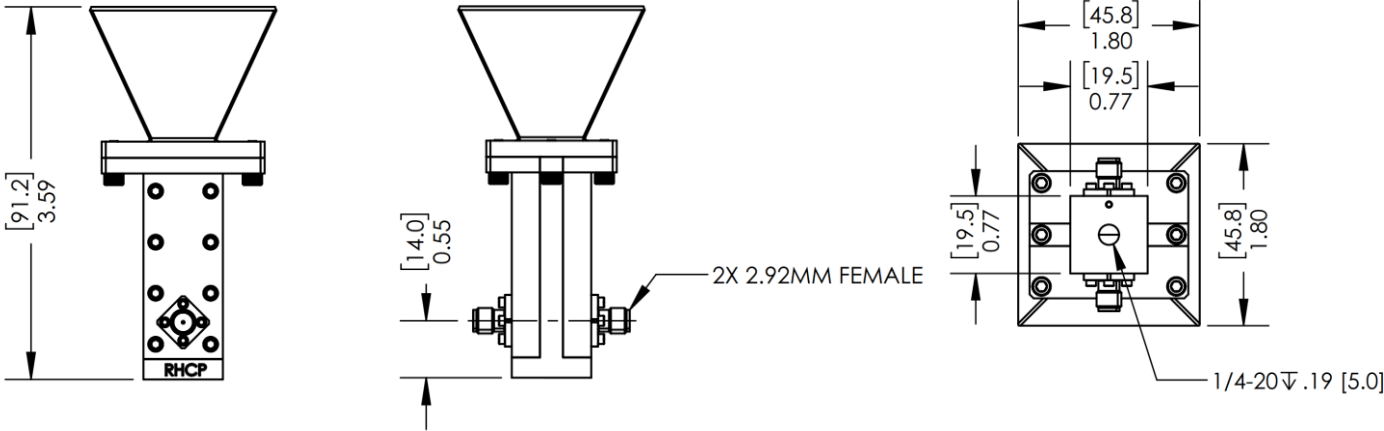

Dimensions shown in inches [millimeters]
Tolerances in millimeters - Integer: ± 3 , One Place Decimal: ± 0.1 , Two Place Decimal: ± 0.05

Contact PlaneWave, Inc.

6925 Canby Ave, Ste 110
Reseda, CA 91335

www.planewaveinc.com
sales@planewaveinc.com